

SUMMATIVE ASSESSMENT – II (2014-2015)
ENGLISH COMMUNICATIVE
Class - X

Time: 3 hours

Maximum Marks: 70

Instructions :

The question paper is divided into **three sections.**

Section A	:	Reading	20 marks
Section B	:	Writing and Grammar	25 marks
Section C	:	Literature	25 marks

SECTION A : READING (20 Marks)

1

Read the following passage carefully :

Ask people whether credit cards are a necessity or a luxury and most would probably term them a necessity these days. Credit cards are considered a boon for the ready convenience they confer on the user - you don't have to worry about carrying enough cash when you go shopping. Just flash your card, sign and walk out. But there are many who criticise credit cards for the 'easy money'. syndrome they generate. It is true that many people fall into a debt trap. But if you're careful with your expenses, they can be a handy thing to have around.

Remember that using a credit card does not mean 'free' credit. In effect, what you are doing is merely postponing payment. While it looks real good to have to pay only one or two thousand a month on your card, remember that you're paying interest on the amount that you 'revolve' from one billing cycle to the next.

But there's one precaution we should add. Always settle a credit card bill in full for two reasons. First and foremost, if you are not able to pay up now, you should not have spent it in the first place. Second, the credit charges tend to be extremely high, ranging from 2 per cent to 3 percent month.

There is no shortage of cards on offer. So, how does one choose among the various cards on offer ? "The factors for choosing a card revolve around certain differentiating features that one card may offer and the others don't, like acceptability, eligibiliy, fees, other charges, credit period, cash advance, etc."

If your credit card is more of a functional accessory while you shop or entertain in your own town, you will want a higher credit limit. Here, foreign and private banks will give you a higher limit. But if you are a value-for - money person who likes the convenience offered by a card, but will alternate between paying by cash and card, you could consider credit cards offered by the public sector banks.

Complete the statements given below :

- (a) Credit cards are considered a boon because _____.
- (b) A credit card does not mean _____.
- (c) The credit charges tend to be extremely high, ranging from _____.
- (d) Some people don't like credit cards because of the _____ generate.
- (e) banks will give you a higher limit.
- (f) The credit charges are very high _____ per month.
- (g) Choice of a credit card depends on its _____.
- (h) If you are not able to pay up your credit card like you should _____.

8

As the tortoise tucks its feet and head inside the shell and will not come out even though you may break the shell into pieces, even so the character of the man who has control over his motives and organs, is unchangeably established. He controls his inner forces, and nothing can draw them out against his will. By this continuous force of good thoughts and good impressions moving over the surface of the mind, the tendency to do good, becomes strong, and in consequence we are able to control the 'Indriyas' (Sense – organs, the nerve centres) in so many ways; meditation being the most popular and most effective. In this way alone is character formed, and only then can one get at the truth. The importance of character in one's life cannot be undermined for nothing is lost when money is gone; when health is lost, something is lost.....but when character is lost, everything is lost. Such a man a man of character is safe forever ; he can not do any evil. You may place him in any company, but there will be no danger for him. There is a still higher state than having this good tendency, and that is the desire for liberation. Liberation means full freedom – freedom from the bondage of evil. A golden chain is as much a chain as an iron one. There is a thorn in my finger, and I use another one to take the first one out ; and when I have taken it out, I throw both of them aside. I have no necessity for keeping the second thorn, because it is a thorn after all. So bad tendencies are to be counteracted by fresh waves of good thoughts and bad impressions on the mind should be removed by the fresh waves of good ones, until all that is evil almost disappears, or is subdued and held in control in a corner of the mind ; but after that the good tendencies also have to be removed. Thus, the attached becomes, unattached and that is the way to live successfully and happily and let others live.

Answer the following questions : (2x4)

1. What does the comparison between man and a tortoise reveal ?
2. Why is it important to control 'Indriyas' ?
3. What is the significance of liberation ?
4. When does the attached become ?

Answer the following questions by choosing the most appropriate options. (1x4)

5. The word 'subdued' means :
(a) passive (b) inactive (c) suppressed (d) dead
6. 'Motive' means :
(a) reason (b) statement (c) idea (d) plan
7. 'Consequence' means :
(a) afterwords (b) result (c) leftover (d) after
8. 'bandage' means :
(a) the state of being a slave (b) prisoner (c) thief (d) vagabond

SECTION B : WRITING AND GRAMMAR (25 Marks)

3	<p>You want to join the TEACH BHARAT PROJECT organized by the NEWS GROUP. Write a letter in about 100-120 words to the editor of a local daily expressing your reasons about the same</p>	5						
4	<p>Develop a story in about 150-200 words on the basis of the following hints :</p> <p>Everyday while returning from school I observe an old man in his rags, It had almost been for years that I had seen him. But on that day when I observed the crowd around that old man lying unconscious on the road I felt something.....</p>	10						
5	<p>Read the following passage. Fill in the blanks by choosing the most appropriate options from the ones given below. Write the answers in your answer sheet against the correct blank numbers. Do not copy the whole passage.</p> <p>The population graph of India goes higher with (a) _____ coming year. It is the moral duty of all (b) _____ citizens to keep a check on it (c) _____ things go out of hand.</p> <p>(a) (i) any (ii) some (iii) every (iv) plenty (b) (i) a (ii) some (iii) the (iv) an (c) (i) after (ii) before (iii) now (iv) then</p>	3						
6	<p>The following paragraph has not been edited. One word has been omitted in each line. Write the omitted word along with the word that comes before and the word which comes after against the blank number.</p> <table border="0" style="margin-left: auto; margin-right: auto;"> <tr> <td></td> <td align="center">Before</td> <td></td> <td align="center">Word</td> <td></td> <td align="center">After</td> </tr> </table> <p>The tribal communities have close relationship (a) _____ with forests. It has estimated that nearly (b) _____ 25 million tribals live in around forests (c) _____ and depend them to a great extent (d) _____</p>		Before		Word		After	4
	Before		Word		After			
7	<p>Rearrange them to form meaningful sentences as given in the example</p> <p>Example : love/toys/children/to/play/with Children love to play with toys.</p> <p>(a) boys/like/baby/only/cars (b) love/girls/ dolls/baby (c) happiness/provide/toys/a/different/kind/of/to/ them</p>	3						

SECTION C : LITERATURE (25 Marks)

Read one of the extracts given below and answer the questions that follow:-

- 8 *Half sunk, a shattered visage lies, whose frown
And wrinkled lip, and sneer of cold command,
Tell that its sculptor well those passions read.* 3
- (a) Which emotion has been depicted on the face of the king?
(b) Explain, 'well those passions read'.
(c) What does 'visage' mean ?

OR

- Your wisdom is consumed in confidence
Do not go forth to-day :* 3
- (i) Who is the speaker and who is he/she talking to ?
(ii) What does 'consumed' mean ? Explain.
(iii) Was the speaker successful in his/her aim ?

Answer the following questions in about 30-40 words each.

- 9(i) How did the conspirators justify their act of murdering Caesar ? 2
- 9(ii) Who was Sebastian Shultz ? Where did he meet Michael ? 2
- 9(iii) Why did the wedding guest begin to beat his breast ? 2
- 9(iv) Why did Patol Babu feel that a single word contained a gold mine, of meaning, in the chapter, 'Patol Babu, Film Star' ? 2

Answer one of the following questions in about 80-100 words:

- 10 "The Rime of the Ancient Mariner" deals with the feelings of guilt. Comment. 4

OR

- Video games could be a wastage of time but they help children in setting the goals and achieving them. Elaborate the statement with reference to the story- ' Virtually True'. 4

Answer one of the following questions in about 150-200 words:

- 11 "A bundle of contradiction"—What does Anne mean by 'contradiction' ? Explain. 10

OR

- What was Mr. Otto Frank's major contribution to the world ? 10

OR

- Why did Helen's mother withdraw Helen and her sister from the Cambridge School ? 10

OR

- Write a character sketch of Mr. Jefferson. 10

-o0o0o0o-

SUMMATIVE ASSESSMENT – II

MATHEMATICS

Class – X

Time allowed : 3 hours

Maximum Marks : 90

General Instructions :

- (i) All questions are **compulsory**.
- (ii) The question paper consists of **31** questions divided into four **sections A, B, C and D**. **Section-A** comprises of **4** questions of **1 mark** each, **Section-B** comprises of **6** questions of **2 marks** each, **Section-C** comprises of **10** questions of **3 marks** each and **Section-D** comprises of **11** questions of **4 marks** each.
- (iii) There is no overall choice.
- (iv) Use of calculator is not permitted.

SECTION-A

Question numbers **1 to 4** carry **one** mark each.

- | | | |
|---|---|---|
| 1 | Find the numerical difference of the roots of the equation $x^2 - 7x - 18 = 0$. | 1 |
| 2 | The ratio of the length of a rod and its shadow is $1 : \frac{1}{\sqrt{3}}$. What is the angle of elevation of the source of light ? | 1 |
| 3 | What is the sum of probabilities of all the elementary events of an experiment ? | 1 |
| 4 | Find co-ordinates of any one point lying on the perpendicular bisector of line segment joining the points $\left(-\frac{1}{2}, 5\right)$ and $\left(\frac{11}{2}, 3\right)$ | 1 |

SECTION-B

Question numbers **5 to 10** carry **two** marks each.

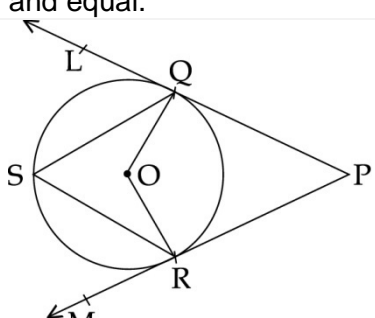
- | | | |
|----|--|---|
| 5 | Find the 7 th term from the end of the AP : 7, 10, 13, ..., 184. | 2 |
| 6 | Find the values of k for which the roots of the quadratic equation, $kx^2 - 5x + k = 0$ are real and equal. | 2 |
| 7 |  <p>PQL and PRM are tangents to a circle with centre O at points Q and R respectively. S is a point on the circle such that $\angle SQL = 50^\circ$ and $\angle SRM = 60^\circ$. Find value of $\angle QSR$.</p> | 2 |
| 8 | Draw a line segment of length 7.8 cm and divide it in the ratio 5 : 8. Measure the two parts. | 2 |
| 9 | Two tangents PA and PB are drawn to the circle with centre O such that $\angle APB = 120^\circ$. Prove that $OA = \sqrt{3} AP$. | 2 |
| 10 | Three solid cubes of a metal whose edges are in the ratio 3 : 4 : 5 are melted and converted into a single cube whose diagonal is $12\sqrt{3}$ cm. Find the edges of the three cubes. | 2 |

SECTION-C

Question numbers **11 to 20** carry **3** marks each.

- | | | |
|----|---|---|
| 11 | How many terms of the AP : 54, 51, 48, ... must be taken so that their sum is 513 ? Explain the double answer. | 3 |
| 12 | Divide 8 into two parts such that the sum of their reciprocals is $\frac{2}{3}$. | 3 |
| 13 | Construct a triangle XYZ in which YZ=7 cm, $\angle Y=45^\circ$ and $\angle Z=90^\circ$. Then, construct another triangle whose sides are $\frac{2}{3}$ of the corresponding sides of $\triangle XYZ$. | 3 |
| 14 | A person walking 45 m towards a tower in a horizontal line through its base observes that angle of elevation of the top of the tower changes from 45° to 60° . Find the height of the tower. | 3 |
| 15 | There are 24 teams participating in a maths competition from 8 different schools, one team per class. The competition is from VIII - X class. Find the probability of :
(a) coming first from each class per school
(b) getting a prize if there are three prizes per class, I, II and III. | 3 |
| 16 | With the help of distance formula, show that the points A(4, 2), B(7, 5) and C(9, 7) do not form a triangle. | 3 |
| 17 | The coordinates of the vertices of $\triangle ABC$ are A(7, 2), B(9, 10) and C(1, 4). If E and F are the mid-points of AB and AC respectively, prove that $EF = \frac{1}{2} BC$. | 3 |
| 18 | A solid metallic cylinder of radius 3.5 cm and height 14 cm is melted and recast into a number of small solid metallic balls, each of radius $\frac{7}{12}$ cm. Find the number of balls so formed. | 3 |
| 19 | In the figure, find the perimeter of the shaded region. | 3 |

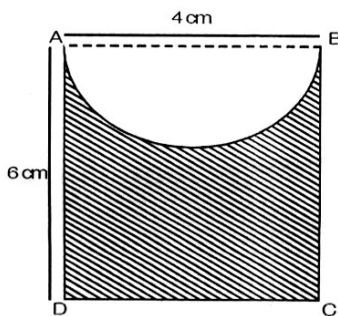

- | | | |
|----|---|---|
| 20 | ABCD is a trapezium with $AB \parallel DC$, $AB=18$ cm, $DC=32$ cm and distance between AB and $DC=14$ cm. If arcs of equal radii 7 cm with centres A, B, C and D have been drawn, then find the area of the region of the trapezium which is not the part of the sectors drawn. | 3 |
|----|---|---|

SECTION-D

Question numbers **21 to 31** carry **4** marks each.

- | | | |
|----|---|---|
| 21 | Mr. John runs a scooter manufacturing factory. His factory produces 1100 scooters in the third year and the production in the eleventh year is 2700. If The production increases by a steady rate every year, find the production of scooters in the 25 th year and the total number of scooters produced in all these 25 years. | 4 |
| 22 | Solve : $\frac{2y}{y-4} + \frac{2y-5}{y-3} = \frac{25}{3}$; $y \neq 3, 4$. | 4 |
| 23 | Find the sum of all numbers between 250 and 1000 which are exactly divisible by 3. | 4 |

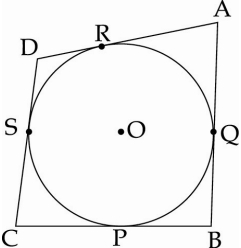
24	<p>In the figure, a circle with centre O is inscribed in a quadrilateral ABCD such that, it touches the sides to be BC, AB, AD and CD at points P,Q,R and S respectively. If AB=29cm, AD=23cm, DS=5cm and $\angle B=90^\circ$, find the radius of the circle.</p>	4
		
25	<p>Draw a line segment PQ of length 9 cm. Taking P as centre, draw a circle of radius 5 cm and taking Q as centre, draw another circle of radius 3 cm. Construct tangents to each circle from the centre of the other circle.</p>	4
26	<p>A 2 m tall boy is standing at some distance from a 29 m tall building. The angle of elevation, from his eyes of the top of the building increases from 30° to 60° as he walks towards the building. Find the distance he walked towards the building.</p>	4
27	<p>Two dice are thrown simultaneously. Evaluate the following.</p> <p>(i) P (sum of the two numbers is 7)</p> <p>(ii) P (sum of the two numbers is at least 3)</p> <p>(iii) P (sum of the two numbers is 1)</p>	4
28	<p>The vertices of $\triangle ABC$ are A(-2, 0), B(2, 0) and C(0, 2) and that of $\triangle PQR$ are P(-4, 0), Q(4, 0) and R(0, 4). Verify that the ratio of the areas of the two triangles is equal to the square of the ratio of their corresponding sides.</p>	4
29	<p>A cylindrical vessel of diameter 14 cm and height 42 cm is fixed symmetrically inside another cylindrical vessel of diameter 16 cm and height 42 cm. The total space between the two vessels is filled with cork dust for heating insulation purpose. How many cubic centimetres of cork dust is required for the purpose ? (Use $\pi = \frac{22}{7}$)</p>	4
30	<p>A truck has front wheels of radius 0.7 m and its rear wheels have radius 1.4 m. If the rear wheel takes 500 revolutions to travel a certain distance, how many revolutions must the front wheel had taken to cover the same distance ? Also, find the difference in their areas.</p> <p>(Use $\pi = \frac{22}{7}$)</p>	4
31	<p>Two types of water tankers are available in a shop at the same cost. One is in a conical form of diameter 1 m and height 2 m and another is in the form of a cylinder of diameter 1 m and height 1.5 m. Calculate the volumes of both the tanker. The shopkeeper advises to purchase cylindrical tank. What value is depicted by the shop keeper ?</p>	4
-o0o0o0o-		

SUMMATIVE ASSESSMENT – II (2014-15)
SCIENCE
Class – X

Time allowed : 3 hours

Maximum Marks : 90

General Instructions :

- (i) The question paper comprises of **two Sections, A and B**. You are to attempt both the sections.
- (ii) **All** questions are **compulsory**.
- (iii) There is no choice in any of the questions.
- (iv) **All** questions of **Section-A** and **all** questions of **Section-B** are to be attempted separately.
- (v) Question numbers **1 to 3** in **Section-A** are **one mark** questions. These are to be answered in **one word** or in **one sentence**.
- (vi) Question numbers **4 to 6** in **Section-A** are **two marks** questions. These are to be answered in about **30 words** each.
- (vii) Question numbers **7 to 18** in **Section-A** are **three marks** questions. These are to be answered in about **50 words** each.
- (viii) Question numbers **19 to 24** in **Section-A** are **five marks** questions. These are to be answered in about **70 words** each.
- (ix) Question numbers **25 to 33** in **Section-B** are multiple choice questions based on practical skills. Each question is a **one mark** question. You are to select one most appropriate response out of the four provided to you.
- (x) Question numbers **34 to 36** in **Section-B** are questions based on practical skills. Each question is a **two mark** question.

SECTION-A

1	Draw the electron dot and cross structure of the main covalent compound present in Compressed Natural Gas (CNG).	1
2	Name the term used for the traits that are exhibited externally .	1
3	Select the item which is made up of biodegradable material-Plastic bag, leather bag, nylon rope, kettle.	1
4	How can change of size of eye ball be one of the reason for : (a) Myopic (b) hypermetropic eye ? Compare the size of eye ball with that of a normal eye in each case. How does this change of size affect the position of image in each case ?	2
5	Explain why do we need to manage our natural resources ?	2
6	Producers always occupy the first trophic level in any food chain. Justify the statement.	2
7	Give an example of each of the following compounds having the following functional group. Write also the names of the examples. Aldehyde, Ketone and Carboxylic acid.	3
8	An element is a main constituent of paper, diamond and clothes etc. It forms covalent bonds with itself and other elements. (i) Identify the element. (ii) Write the electron dot structure of its oxide. (iii) Draw the electron dot structure of methane and ethane.	3
9	Where do we find non – metals in the periodic table ? Do non – metals lose or gain electrons to attain nearest inert gas configuration ? What is the nature of their oxides ?	3
10	Explain how the tendency of metallic character changes on moving down a group in the periodic table ?	3

11	Homologous organs are different from analogous organs. (a) Mention the two basic characteristics that decide about analogy and homology between the two organs. (b) On what basis is the classification of organisms into Prokaryotic and Eukaryotic done?	3																					
12	It was observed that in a family a woman has only daughters. Analyse on the basis of genetics and give an explanation.	3																					
13	Pick out the incorrectly labeled parts and correct these. Also mention the function of vagina.	3																					
14	Variation is useful for the survival of species over long time. But the variants have unequal chances of survival. Explain this statements	3																					
15	Budding is a type of asexual reproduction used by <i>Hydra</i> . (a) What is meant by asexual reproduction ? How is it different from sexual reproduction ? (b) Name any other type of asexual reproduction used by <i>Hydra</i> ? Define it.	3																					
16	(a) A man is suffering from hypermetropia. State the difficulty which the person must be facing due to this defect. (b) Draw ray diagram to explain the image formation by (i) hypermetropic eye (ii) correction made with lens	3																					
17	A student using a convex lens of focal length 20 cm, formed image of an object placed in front of the lens on one side a screen placed on the other side of the lens. He noted the following reading for object distance (u) and image distance (v) from lens.	3																					
	<table border="1"> <thead> <tr> <th>S.No</th> <th>1</th> <th>2</th> <th>3</th> <th>4</th> <th>5</th> <th>6</th> </tr> </thead> <tbody> <tr> <td>u (cm)</td> <td>60</td> <td>45</td> <td>40</td> <td>32</td> <td>35</td> <td>15</td> </tr> <tr> <td>v (cm)</td> <td>30</td> <td>36</td> <td>45</td> <td>53</td> <td>25</td> <td>10</td> </tr> </tbody> </table>	S.No	1	2	3	4	5	6	u (cm)	60	45	40	32	35	15	v (cm)	30	36	45	53	25	10	
S.No	1	2	3	4	5	6																	
u (cm)	60	45	40	32	35	15																	
v (cm)	30	36	45	53	25	10																	
	Without using lens formula, comment, which of these observations are wrong. Justify your answer.																						
18	On the day of Van mahotsav students took a pledge to protect trees in their school. (a) List any two values shown by them by doing so. (b) Mention any two ways to protect trees in your area.	3																					
19	Complete the following chemical reactions and write the chemical name of the products obtained. (i) $CH_2 = CH_2 + H_2O \rightarrow$ (ii) $CH_3COOH + NaOH \rightarrow$ (iii) $CH_3CH_2OH \xrightarrow{H_2SO_4}$ (iv) $HCOOH + Na \rightarrow$ (v) $C_2H_5OH \xrightarrow{alk.KMnO_4}$	5																					

20	Give reasons for the following : (a) Traits acquired during lifetime of an individual are not inherited. (b) All the human beings belong to a single species. (c) Variations keep on accumulating during reproduction, and do not disappear in next generation.	5
21	Differentiate between the following : (a) Pollen tube and Style (b) Fission in <i>Amoeba</i> and <i>Plasmodium</i> (c) Fragmentation and Regeneration (d) Bud of <i>Hydra</i> and bud of <i>Bryophyllum</i> (e) Vegetative propagation and Spore formation	5
22	(a) Demonstrate an activity with a well labelled diagram to prove that white light is made up of seven colours. (b) Which colour of light bends least and which one the most while passing out from the prism. Also state the reason for the same.	5
23	Study the following situation and answer the questions that follow : A spherical mirror produces an image 48 cm in front of it, when an object is placed at a distance of 12 cm from its pole. Calculate the focal length of the mirror and answer the following : (a) Identify the nature of mirror. (b) Will the image be magnified or diminished ? (c) State whether the image formed is real or virtual. (d) Will the image formed be erect or inverted. (e) Draw ray diagram, showing the formation of image in the above case. (not to scale)	5
24	(a) Write relation between u, v, f for lens and for mirrors where u, v, f are object distance, image distance and focal length respectively. (b) The magnification produced by a concave mirror is $m=+4$. Write the information about the image given by this statement. (c) Draw a ray diagram for the following and show the formation of the images in case of concave mirror when the object is placed : (i) Between the pole and focus point (ii) at the centre of curvature	5
SECTION - B		
25	Chemicals required to prepare soap are : (a) oil/fat + NaOH + NaCl (b) oil/fat + Ca(OH) ₂ + NaCl (c) oil/fat + NaOH + CaCO ₃ (d) oil/fat + Ca(OH) ₂ + Na ₂ CO ₃	1
26	The most suitable temperature of hot water bath during Saponification process is : (a) below 50°C (b) about 85°C (c) above 100°C (d) room temperature	1
27	Name of the salt from the following which makes the water hard is : (a) calcium hydrogen carbonate (b) potassium chloride (c) sodium carbonate (d) sodium bicarbonate	1
28	Out of the following, the best way to do experiment for finding the focal length of a concave mirror by obtaining the image of a distant object is to (a) hold the mirror in a stand and hold the screen in hand in front of the mirror. (b) hold the mirror in hand and keep the screen in a stand behind the mirror. (c) keep both the mirror and the screen in suitable stands keep and the screen behind the mirror. (d) keep both the mirror and the screen in suitable stands with screen put in front of the mirror.	1

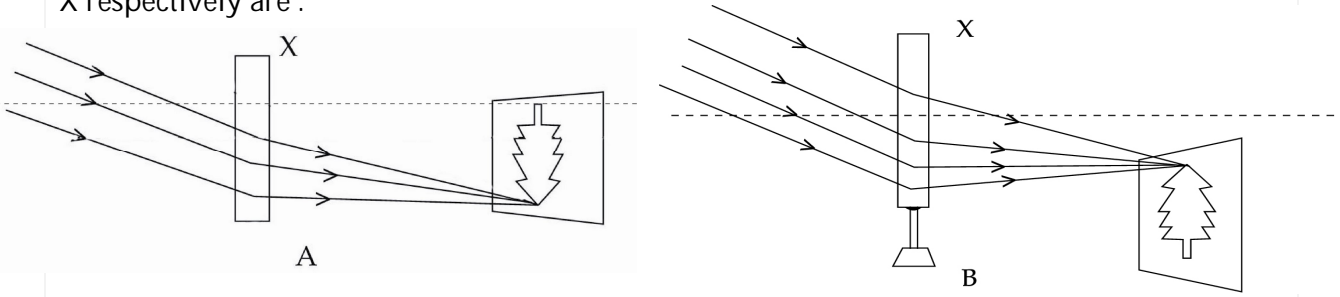
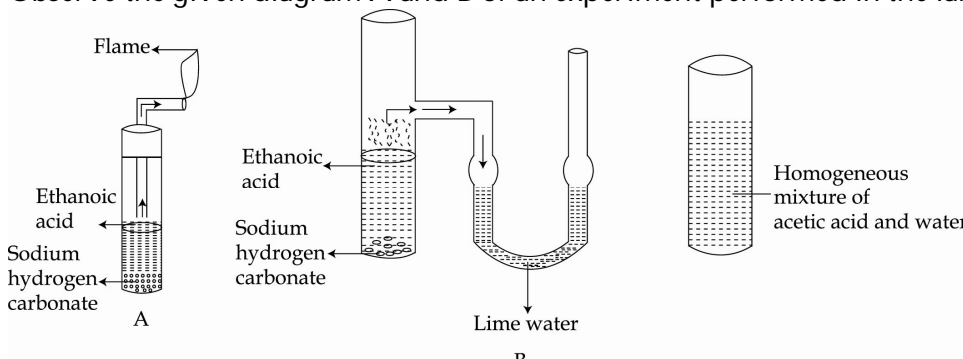
29	<p>Parallel rays , from a distant tree, incident on the device X, form its distinct image on a screen as shown. The diagram, correctly showing the image of the tree on the screen, and the device X respectively are :</p> 	1
	<p>(a) 'A' and convex lens (c) 'B' and convex lens</p>	
	<p>(b) 'A' and concave mirror (d) 'B' and concave mirror</p>	
30	<p>A ray of light travelling in a rarer transparent medium meets the surface of a denser transparent medium. While entering the second medium at the point of incidence, it :</p>	1
31	<p>While doing the experiment to trace the path of light ray through a triangular glass prism the, student does not get the image of object (pins). This may be because :</p>	1
32	<p>Tendrils in passiflora are modified stem, tendrils in Pea are modified leaflets and thorns of Bougainvillea are modified stem. The analogous organs are of :</p>	1
33	<p>If the radicle of the dicotyledonous seed accidentally gets detached from it, the possible consequence can be that :</p>	1
34	 <p>Identify the gas evolved in A and B, what will happen to the flame and lime water as shown in the diagrams ?</p>	2
35	<p>A student was asked to identify a difference in the nucleus of Binary fission in Amoeba and budding in yeast. What would be the possible correct difference identified by her ?</p>	2
36	<p>In the following ray diagram.</p>	2

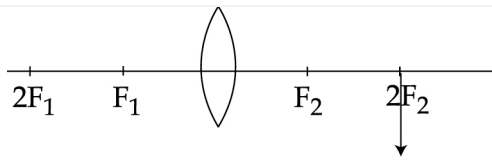

- (i) What will be the position of the object ?
- (ii) Compare the size of image A' B' with the object.

-o0o0o0o-

SUMMATIVE ASSESSMENT – II (2014-15)**SOCIAL SCIENCE****Class – X****Time allowed : 3 hours****Maximum Marks : 90****General Instructions :**

- (i) The question paper has **30** questions in all. All questions are **compulsory**.
- (ii) Marks are indicated against each question.
- (iii) Questions from serial number **1 to 8** carries **1 mark each**.
- (iv) Questions from serial number **9 to 20** are **3 mark** questions. Answer of these questions should not exceed **80 words** each.
- (v) Questions from serial number **21 to 28** are **5 mark** questions. Answer of these questions should not exceed **120 words** each.
- (vi) Question number **29 and 30** are of History and Geography map questions of **3 marks each**. After completion, attach the map inside your answer book.

1	Who formed Swaraj Party ?	1
2	Name the minerals formed in beds and layers.	1
3	What is meant by political activist ?	1
4	State the meaning of a political party	1
5	State the meaning of democracy.	1
6	What is meant by exports ?	1
7	If a case is dismissed in district level court where can a consumer appeal ?	1
8	What is the main source of income for the banks ?	1
9	"British rule in India would have collapsed if Indians had not cooperated". How did this statement help in starting a mass movement in India against the British rule ?	3
10	Explain the main features of the Gudem rebellion.	3
11	Mention any three important contributions by Romanticists to national movements.	3
	OR	
	Why was the bounty programme of Rat Hunt scrapped ? Explain	3
12	Why is cotton textile industry concentrated in Maharashtra and Gujarat ? Give any three reasons.	3
13	How has India one of the largest terrestrial networks of Doordarshan in the world ? Explain.	3
14	"India's future is very bright in solar energy." Support the statement.	3
15	Why has political funding become a threat for democracy ?	3

16	How do pressure groups and movements exert influence on politics ?	3
17	How does democracy accommodate social diversities ?	3
18	Explain any three possible reasons that people might apply for loans in rural areas ?	3
19	What is consumer exploitation ? Which law protects the consumers from exploitation ?	3
20	How SHGs are the best source to help the poor people ?	3
21	What do you mean by sense of collective belongingness and how was it practised in India by the Indians ? Explain.	5
22	Describe any five events that led to the emergence of France as a nation.	5
	OR	
	Who was the founder of Hoa Hao movement ? How was this movement suppressed by the French ?	5
23	Describe any five problems faced by cotton textile industry in India.	5
24	Explain any five advantages of non-conventional sources of energy over conventional sources of energy.	5
25	Critically examine the multi-party system of India.	5
26	Describe prudential reasons in favour of democracy.	5
27	In what five ways competition has affected workers and Indian exporters in the garment industries ? Explain	5
28	How far has the right to represent been implemented in India ? Explain.	5
29	Two features (A) and (B) are marked in the given outline political map of India. Identify these features with the help of the following information and write their correct names on the lines marked in the map. (A) The place where Jallianawala Bagh incident took place. (B) The place where the Non-Cooperation movement became violent. On the same political outline map of India locate and label the following items with appropriate symbols. (C) Calcutta : The place of the session of Indian National Congress in Sept 1920.	3
30	Two features A and B are shown in the given political outline map of India. Identify these features with the help of following information and write their correct names on the lines marked on the map. (A) A major sea port (B) Cotton textile centre On the same political outline map of India, locate and label the following feature with appropriate symbol. (C) Rawat Bhata nuclear power plant	3
	-o0o0o0o-	

Roll No. _____

Date _____

Q.29

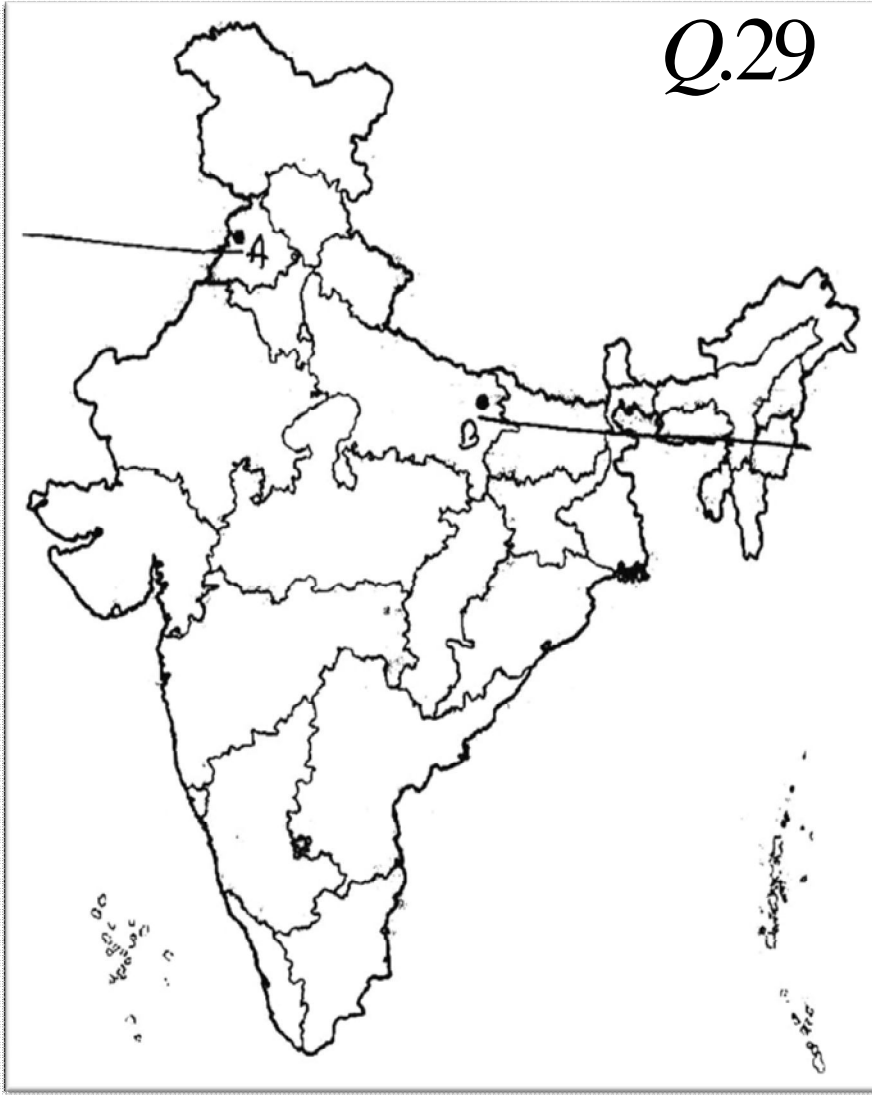

Roll No. _____

Date _____

Q.30

